

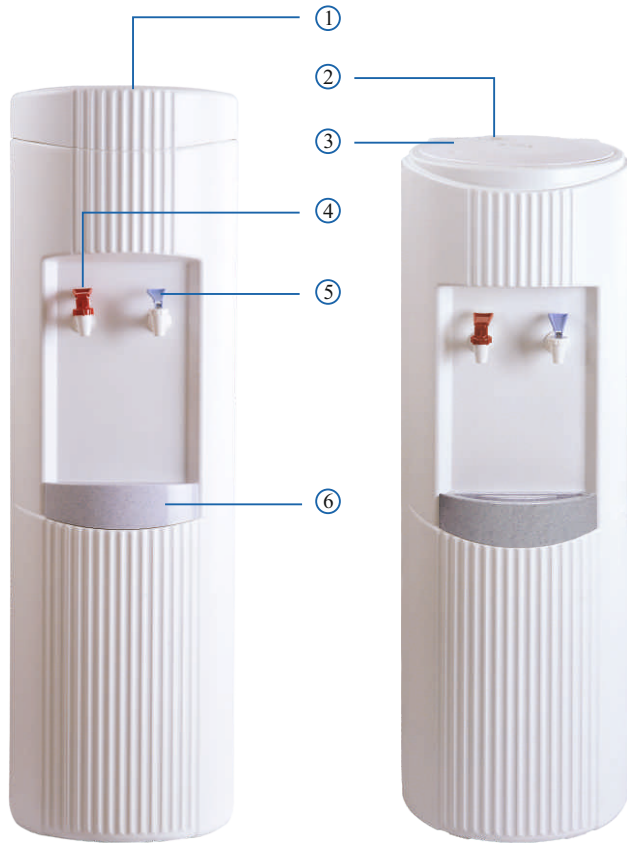

GLACIER

POU Water Dispenser User Manual



1. POU Cover
2. Reset Button
3. POU Kit
4. Touch Guard® Hot Water Faucet
5. Cold Water Faucet
6. Drip Tray

■ Parts may not appear exactly as shown

THANK YOU FOR BUYING A CRYSTAL MOUNTAIN WATER COOLER!

RECEIVING

Inspect the cooler box for any evidence of shipping or handling damage. In case of shipping damage, claims should be filed promptly with the carrier. Please note that the carrier will not accept claims for any damage discovered after the signing for UNINSPECTED GOODS. Ensure cooler stands upright for 24 hours before plugging it in.

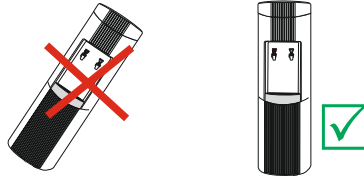

Failure to use an appropriate leak detector and shutoff valve device for any reason will not obligate or make Crystal Mountain responsible in any way for Product Liability issues relating to any claims, including water damage claims.

OPERATION

1. Place the water cooler on a flat level surface in a cool shaded location near a grounded wall outlet. Position water dispenser so that the back of the unit is a minimum of 2 inches / 5cm away from the wall to ensure proper ventilation (Figure 1).
2. Installation should only be executed by properly trained personnel. The connection must be to the potable mains water supply and should be via a shut off valve. An anti-flood device should be fitted as close as possible to the mains connection point. In line with local regulations, a check or non-return valve must also be fitted prior to the equipment (Figure 2).

Water Inlet Pressure:

- Minimum 20PSI (0.138MPa)
- Maximum 80PSI (0.552MPa)
- Where pressures exceed 80PSI (0.552MPa) a Pressure Reducing Valve must be fitted

Note: On H&C models, vent the hot tank by holding the red faucet open until water flows out. (Heater switch may now be turned on (Figure 3))

3. Ensure that the available power supply matches the cooler's voltage specifications indicated on the nameplate label (located at the rear). Plug power supply cord into receptacle (Figure 4). Please ensure that cooler is set up so as access to the power outlet and plug is unobstructed. (Use of an extension cord will void the warranty)

Note: To provide additional protection from the risk of shock, this unit MUST be connected to a ground fault circuit interrupter (GFCI) outlet at all times. Use of an Extension cord will void any warranties.

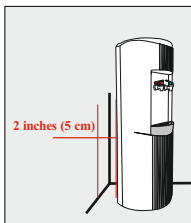

Figure 1

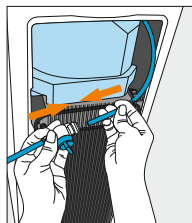

Figure 2

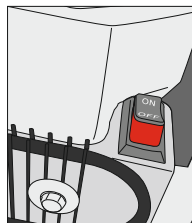

Figure 3

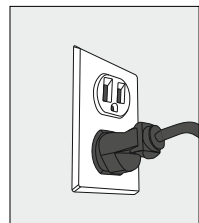

Figure 4

4. Do not draw water from the cooler for about 30 minutes to let the water cool or heat. Optimum water temperatures will be reached after several hours of operation (Figure 5 and Figure 6).

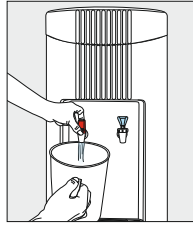

Figure 5

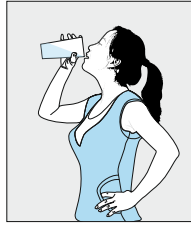

Figure 6

5. Ensure the following when cooler is to be serviced:

- 5.1 Turn off Hot Tank Switch (Hot & Cold models only) and disconnect power supply cord (Figure 7 to Figure 8).
- 5.2 Turn off the water supply via the shut off valve, and disconnect the water supply from the cooler (Figure 9).

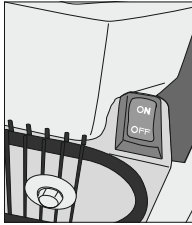

Figure 7

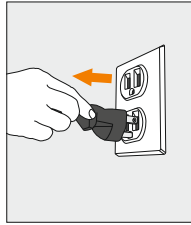

Figure 8

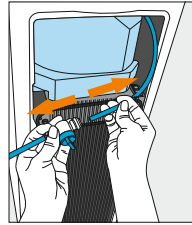

Figure 9

5.3 Use a bucket to drain water from the cold water reservoir through faucets (Figure 10). On Hot & Cold models, turn off hot tank switch as above (Figure 11). Allow 1 hour for the hot water to cool down inside the hot water tank. Remove the drain plug at the rear of the cooler to drain into a container (Figure 12 and Figure 13).

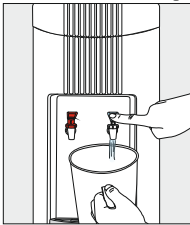

Figure 10

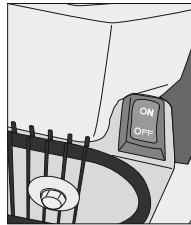

Figure 11

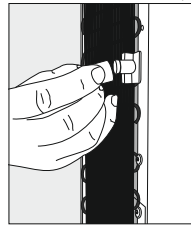

Figure 12

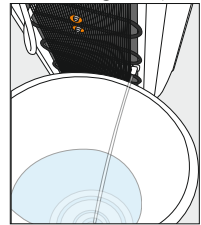

Figure 13

CAUTION! ALWAYS DRAIN WATER COMPLETELY BEFORE SHIPPING OR STORING THE COOLER!

Reservoir Removal (E&S Series)

On Cook & Cold and Hot & Cold models the reservoir can be removed easily by following the steps given below.

- 1. Unplug and approach the cooler from the front (Figure 14).
- 2. Turn off the water supply via the shut off valve, and disconnect the water supply from the cooler. (Figure 15)

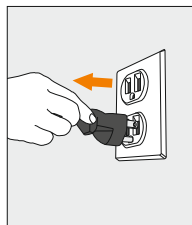

Figure 14

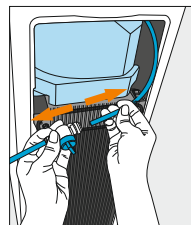

Figure 15

3. Remove the POU Cover (if installed) (Figure 16) Use the fingertips of both hands to press on the POU Lid Assembly and turn counter clockwise till it is free from the cooler opening. (Figure 17 and Figure 18) Lift off of the cooler, and set aside. Drain the water from the reservoir and hot tank (Figure 19), remembering to cool and drain hot tank. Allow 1 hour for hot water to cool down.

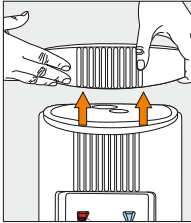

Figure 16

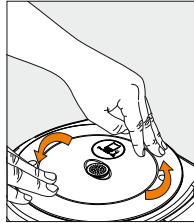

Figure 17

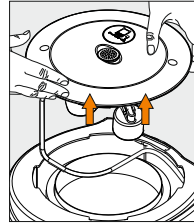

Figure 18

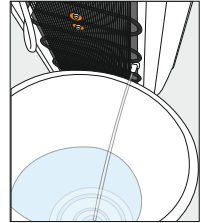

Figure 19

4. Using fingers of both hands to lift up and remove the insulation jacket covering the reservoir, from the cooler opening (Figure 20 and Figure 21)

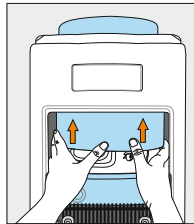

Figure 20

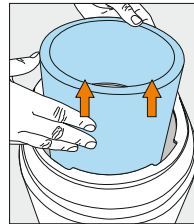

Figure 21

5. Remove the baffle cup by lifting straight out (Figure 22). Loosen & remove the baffle stem and wing nut by turning counter-clockwise (Figure 23 and Figure 24).

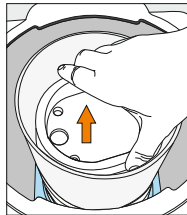

Figure 22

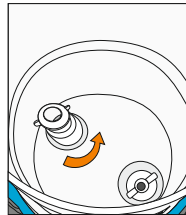

Figure 23

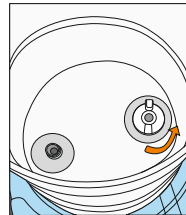

Figure 24

6. Approach the cooler from the rear and open the latch provided on the evaporator band (Figure 25)
7. Use both hands, loosen the reservoir from the evaporator band and lift it straight through the cooler opening (Figure 26)

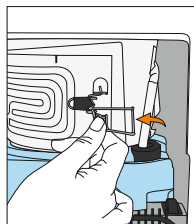

Figure 25

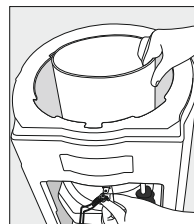

Figure 26

R, P & G Series

On Cook & Cold and Hot & Cold models the reservoir can be removed easily by following the steps given below.

1. Unplug and approach the cooler from the front (Figure 27)

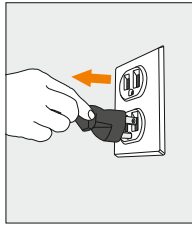

Figure 27

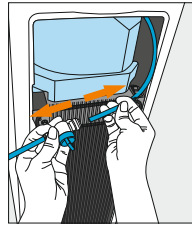

Figure 28

3. Remove the POU Cover (if installed) (Figure 29) Use the fingertips of both hands to press on the POU Lid Assembly and turn counter clockwise till it is free from the cooler opening. (Figure 30, Figure 31) Lift off of the cooler, and set aside. Drain the water from the reservoir and hot tank (Figure 32), remembering to cool and drain hot tank. Allow 1 hour for hot water to cool down.

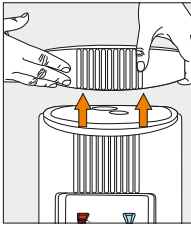

Figure 29

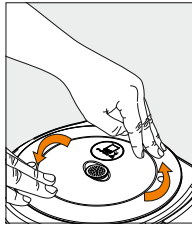

Figure 30

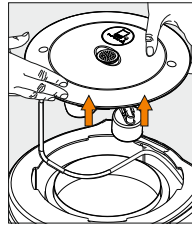

Figure 31

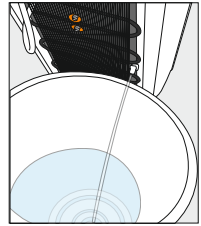

Figure 32

4. Using fingers of both hands, loosen and remove the insulation jacked covering the plastic reservoir from the cooler opening (Figure 33). (Note: On Hot & Cold models, after step 4 unscrew the round plastic one piece baffle) (Figure 34)

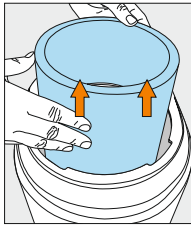

Figure 33

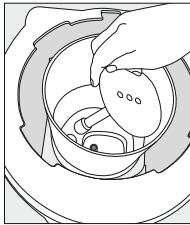

Figure 34

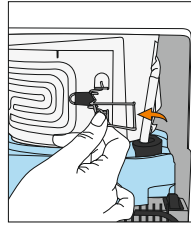

Figure 35

6. Remove the faucets from the reservoir elbows by turning them counter-clockwise (Figure 36)

7. Use both hands, loosen the reservoir from the evaporator band and lift it straight through the cooler opening (Figure 37)

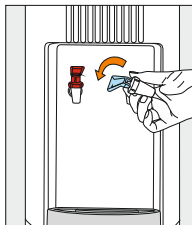

Figure 36



Figure 37

CLEANING

Do Not Immerse the Unit in Water for Cleaning

Remove any dust or contaminants from the cooler by rinsing the cold water reservoir and faucets with clean water prior to use (Figure 38 and Figure 39). Use only mild dishwashing liquid detergent for cleaning the exterior surfaces. **DO NOT USE** bleach or abrasive cleaners.

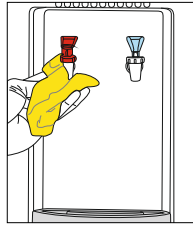

Figure 38

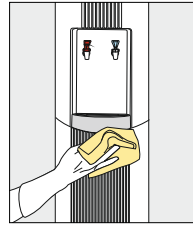

Figure 39

Note: The product you have purchased may look different than the model shown in (Figure 50).

- Parts may not appear exactly as shown

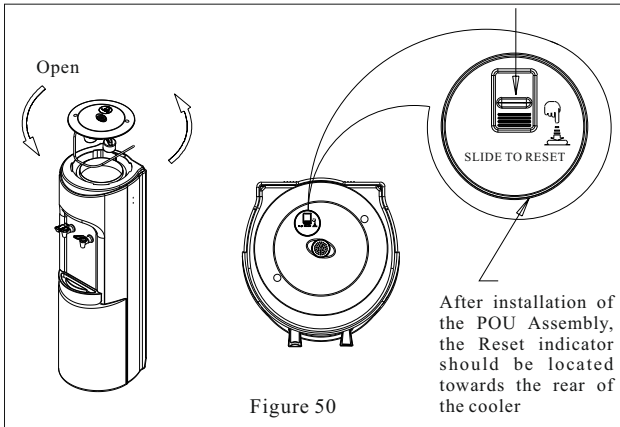

Figure 50

Standup Series Bracket Installation Instructions

INSTALLATION

1. Remove the two mounting screws that secure the Bottom Plate to the outer enclosure.
2. While holding the "S" shaped bracket against the cooler (refer to diagram) reinstall and tighten the bottom plate/outer enclosure screws securely.
3. Place the cooler in position against the wall and using the "S" bracket, mark the location of the wall insert holes to be drilled (if required). If not required, secure the cooler to the wall using the two screws provided.

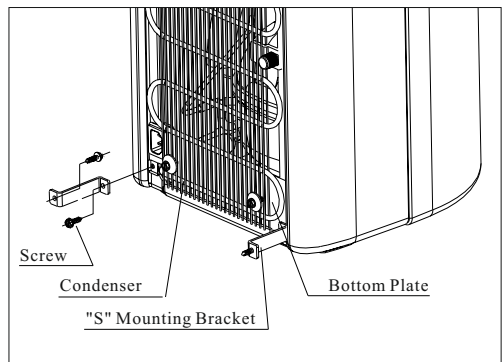

Figure 51

WARNING:

The warranty and Underwriters' Laboratory and CE listings for the coolers are invalidated if any alteration, modification, or use or misuse in combination with any other machine or devices is deemed to be the source of any claim. The manufacturer accepts no liability (including for bodily injury) resulting from any alteration, misuse, neglect, accidents, improper installations or repairs.

The Red Faucet dispenses hot water during normal operation that may cause severe burns.

This appliance is not intended for use by persons (including children) with reduced physical, sensory or mental capabilities, or lack of experience and knowledge, unless they have been given supervision or instruction concerning use of the appliance by a person responsible for their safety.

Children should be supervised to ensure that they do not play with the appliance.

If the supply cord is damaged, it must be replaced by a special cord or assembly available from the manufacturer or its service agent.



This marking indicates that this product should not be disposed of with other household wastes throughout the EU. To prevent possible harm to the environment or human health from uncontrolled waste disposal, recycle it responsibly to promote the sustainable reuse of sustainable resources. To return your used device, please use the return and collection systems or contact the retailer where the product was purchased. They can take this product for environmentally safe recycling.

The customer acknowledges that water, like other liquids, can cause damage to surfaces. The customer takes full responsibility for placing the cooler within a residence or business, and acknowledges that failure to address drips, leaks or spillages is at the customer's risk.

Failure to use an appropriate leak detector and shutoff valve device for any reason will not obligate or make Crystal Mountain responsible in any way for Product Liability issues relating to any claims, including water damage claims.

Environmental application temperature: 10~32°C.

The unit is rated IP10. (This unit is not protected against ingress of water)

For more information on this product, please visit www.crystalcoolers.com